

FRDM-17510EJ-EVB Evaluation Board

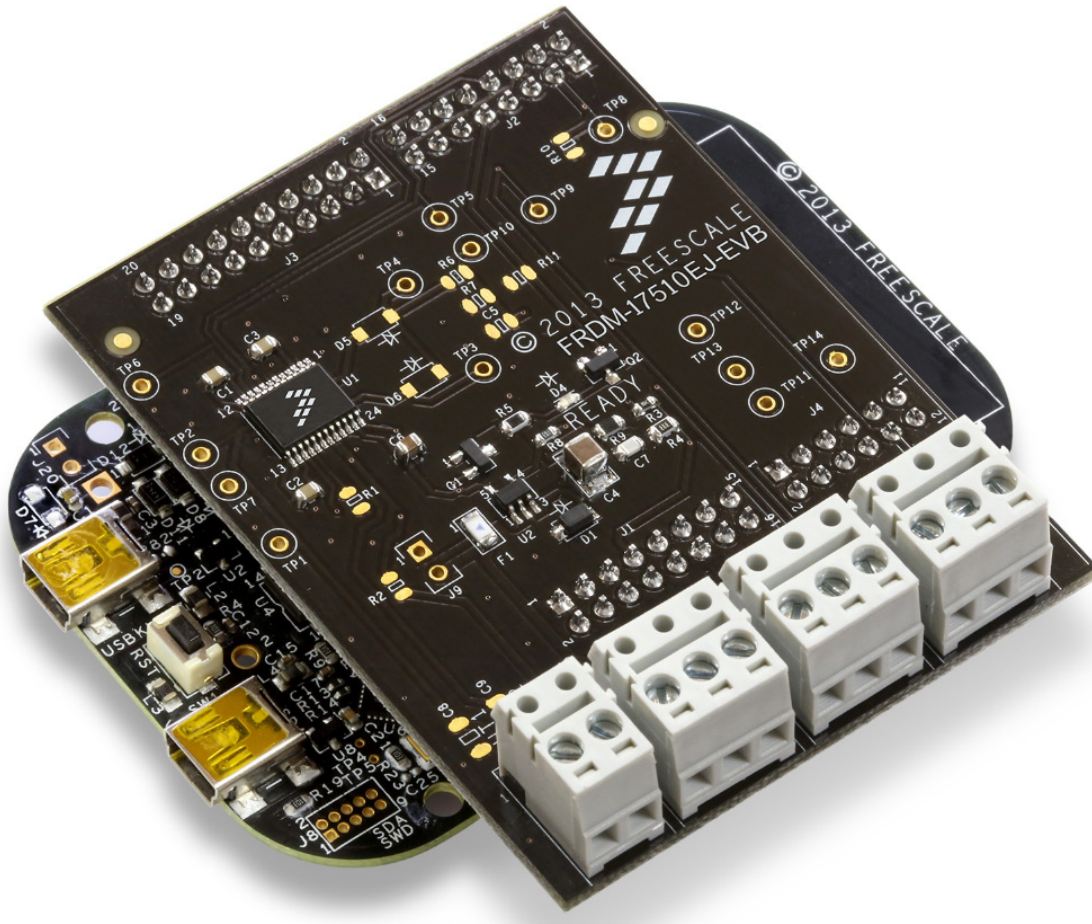

Figure 1. FRDM-17510EJ-EVB Evaluation Board



Contents

1	Important Notice.....	3
2	Getting Started.....	4
3	Getting to Know the Hardware.....	5
4	FRDM-KL25Z Freedom Development Platform.....	9
5	Installing the Software and Setting up the Hardware.....	12
6	Installing the Processor Expert Software.....	15
7	Schematic.....	27
8	Board Layout.....	28
9	Board Bill of Materials.....	29
10	References.....	30
11	Revision History.....	31

1 Important Notice

Freescale provides the enclosed product(s) under the following conditions:

This evaluation kit is intended for use of ENGINEERING DEVELOPMENT OR EVALUATION PURPOSES ONLY. It is provided as a sample IC pre-soldered to a printed circuit board to make it easier to access inputs, outputs, and supply terminals. This evaluation board may be used with any development system or other source of I/O signals by simply connecting it to the host MCU or computer board via off-the-shelf cables. This evaluation board is not a Reference Design and is not intended to represent a final design recommendation for any particular application. Final device in an application will be heavily dependent on proper printed circuit board layout and heat sinking design as well as attention to supply filtering, transient suppression, and I/O signal quality.

The goods provided may not be complete in terms of required design, marketing, and or manufacturing related protective considerations, including product safety measures typically found in the end product incorporating the goods. Due to the open construction of the product, it is the user's responsibility to take any and all appropriate precautions with regard to electrostatic discharge. In order to minimize risks associated with the customers applications, adequate design and operating safeguards must be provided by the customer to minimize inherent or procedural hazards. For any safety concerns, contact Freescale sales and technical support services.

Should this evaluation kit not meet the specifications indicated in the kit, it may be returned within 30 days from the date of delivery and will be replaced by a new kit.

Freescale reserves the right to make changes without further notice to any products herein. Freescale makes no warranty, representation or guarantee regarding the suitability of its products for any particular purpose, nor does Freescale assume any liability arising out of the application or use of any product or circuit, and specifically disclaims any and all liability, including without limitation consequential or incidental damages. "Typical" parameters can and do vary in different applications and actual performance may vary over time. All operating parameters, including "Typical", must be validated for each customer application by customer's technical experts.

Freescale does not convey any license under its patent rights nor the rights of others. Freescale products are not designed, intended, or authorized for use as components in systems intended for surgical implant into the body, or other applications intended to support or sustain life, or for any other application in which the failure of the Freescale product could create a situation where personal injury or death may occur.

Should the buyer purchase or use Freescale products for any such unintended or unauthorized application, the buyer shall indemnify and hold Freescale and its officers, employees, subsidiaries, affiliates, and distributors harmless against all claims, costs, damages, and expenses, and reasonable attorney fees arising out of, directly or indirectly, any claim of personal injury or death associated with such unintended or unauthorized use, even if such claim alleges Freescale was negligent regarding the design or manufacture of the part. Freescale™ and the Freescale logo are trademarks of Freescale Semiconductor, Inc. All other product or service names are the property of their respective owners. © Freescale Semiconductor, Inc. 2015

2 Getting Started

2.1 Kit Contents/Packing List

The **FRDM-17510EJ-EVB** contents include:

- Assembled and tested evaluation board/module in anti-static bag.
- Warranty card

2.2 Jump Start

Freescalé's analog product development boards help to easily evaluate Freescalé products. These tools support analog mixed signal and power solutions including monolithic ICs using proven high-volume SMARTMOS mixed signal technology, and system-in-package devices utilizing power, SMARTMOS and MCU dies. Freescalé products enable longer battery life, smaller form factor, component count reduction, ease of design, lower system cost and improved performance in powering state of the art systems.

- Go to www.freescale.com/FRDM-17510EJ-EVB
- Locate your kit
- Review your Tool Summary Page
- Look for



- Download documents, software and other information

Once the files are downloaded, review the user guide in the bundle. The user guide includes setup instructions, BOM and schematics. Jump start bundles are available on each tool summary page with the most relevant and current information. The information includes everything needed for design.

2.3 Required Equipment

To use this kit, you need:

- DC Power supply (2.0 to 15 V, 0.1 to 1.2 A, depending on brushed DC motor requirements)
- USB A to mini-B cable
- FRDM-KL25Z Freedom Development Platform
- Typical loads (brushed DC motor or power resistors)
- 3/16" blade screwdriver
- Oscilloscope (preferably 4-channel) with current probe
- Digital multi-meter
- One 12-pin (PPTC062LFBN-RC), two 16-pin (PPTC082LFBN-RC), and one 20-pin (PPTC102LFBN-RC) female connector, by Sullins Connector Solutions, or equivalent soldered to FRDM-KL25Z

2.4 System Requirements

To use this kit, you need:

- USB-enabled PC with Windows XP or higher

3 Getting to Know the Hardware

3.1 Board Overview

The FRDM-17510EJ-EVB evaluation board features the MPC17510EJ H-Bridge IC, which features the ability to drive brushed DC motors in both directions. The MPC17510EJ incorporates internal control logic, a charge pump, gate drive, and high current, low $R_{DS(on)}$ MOSFET output circuitry. An auxiliary gate drive for an external MOSFET circuit is also available.

3.2 Board Features

The FRDM-17510EJ-EVB evaluation board is designed to be able to easily evaluate and test the main component, the MPC17510EJ. The board's main features are as follows:

- Compatible with Freedom series evaluation boards such as FRDM-KL25Z
- Built in fuse for both part and load protection
- Screw terminals to provide easy connection of power and loads
- Test points to allow probing of signals
- Built in voltage regulator to supply logic level circuitry
- LED to indicate status of the on board voltage regulator

3.3 FRDM-KL25Z Features

The features of the FRDM-KL25Z are as follows:

- MKL25Z128VLLK4 in an 80 LQFP package
- Capacitive touch slider
- MMA8451Q accelerometer
- Tri-color (RGB) LED
- Flexible power supply options – USB, coin cell battery, external source
- Battery-ready, power-measurement access points
- Easy access to MCU I/O via Arduino™ R3 compatible I/O connectors

3.4 Device Features

This evaluation board features the following Freescale product:

Table 1. Device Features

Device	Description	Features
MPC17510EJ	The MPC17510EJ is an H-Bridge motor driver IC intended for operating brushed DC motors.	<ul style="list-style-type: none"> • Wide voltage range of operation from 2.0 V to 15 V • Output Current of 1.2 A (DC) continuous, 3.8 A peak • 450 mΩ $R_{DS(on)}$ H-Bridge MOSFET outputs • 5.0 V TTL/CMOS compatible inputs • PWM frequencies up to 200 kHz • Undervoltage Shutdown • Cross conduction (shoot through) suppression

3.5 Board Description

This evaluation board consists mainly of an MPC17510EJ. The following sections describe the additional hardware used to support the H-Bridge driver.

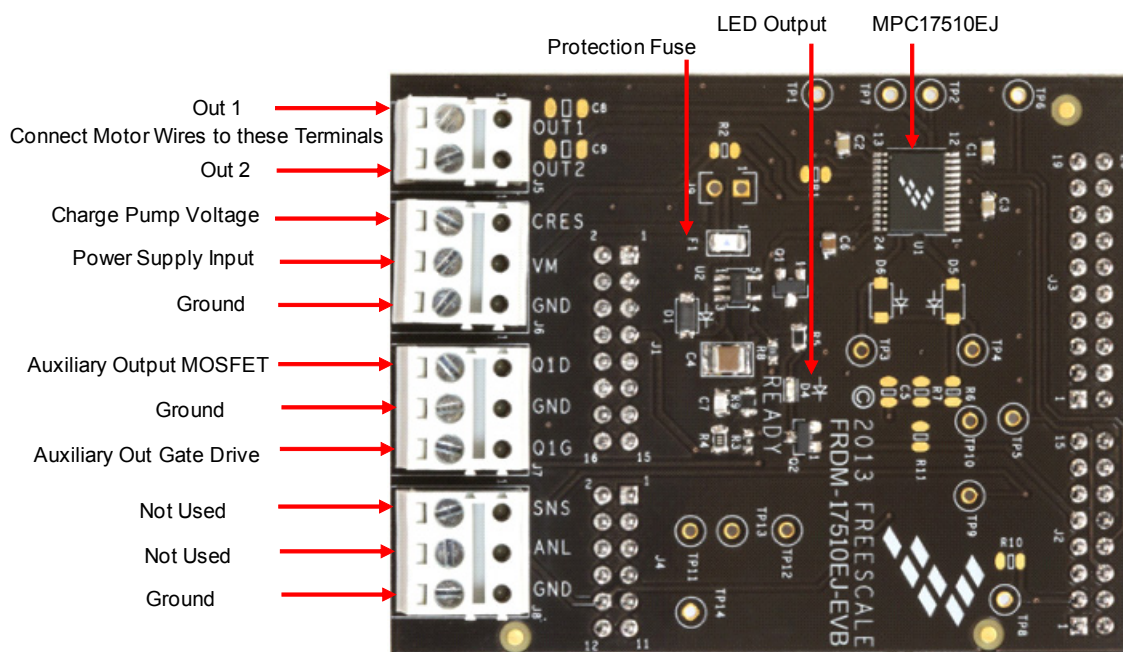

Figure 2. Board Description

Table 2. Board Description

Name	Description
U1	MPC17510EJ H-Bridge motor driver IC
F1	Over current Protection Fuse
D4	User defined LED output
OUT1	Output 1 Connect motor lead to this terminal
OUT2	Output 2 Connect motor lead to this terminal
CRES	Charge pump voltage
VM	Power Supply Input
GND	Ground Terminal
Q1D	Auxiliary Output of on board MOSFET (drain)
GND	Ground Terminal
GOUT	Boosted gate drive Auxiliary output
SNS	Not used – connection to FRDM-KL25Z input
ANL	Not used – connection to FRDM-KL25Z input
GND	Ground Terminal

3.6 LED Indicator

An LED is provided as a visual output device for the FRDM-17510EJ-EVB evaluation board:

Table 3. LED Display

LED ID	Description
LED1	LED1 (D4 board designator) is illuminated with an output from the FRDM-KL25Z. The on board voltage regulator must be operating for the LED to operate.

3.7 Test Point Definitions

The following test-points provide access to signals on the FRDM-17510EJ-EVB.

Table 4. Test Point Definitions

TP #	Signal Name	Description
TP1	GOUT	General Purpose Output (MOSFET output)
TP2	OUT1	This is output 1 of the MPC17510EJ H-Bridge
TP3	OUT2	This is output 2 of the MPC17510EJ H-Bridge
TP4	OUT1 + OUT2	This test point is not used
TP5	IN1	Analog Multiplexer output pin
TP6	IN2	SPI serial Clock
TP7	EN	SPI Master out - Slave in
TP8	GIN	SPI Master In - Slave Out
TP9	SNSIN	Not Used
TP10	ANLIN	Not Used
TP11	VDDPWRGOOD	Signal to microcontroller indicating the voltage regulator is operating (5.0 V)
TP12	READY	Logic signal from microcontroller. This signal causes the green LED to operate.
TP13	VDD	Logic Power Supply from the voltage regulator on the board
TP14	GND	Ground Connection

3.8 Input Signal Definitions

The MPC17510EJ IC has four input signals that are used to control certain outputs or functions inside the circuit. These signals are:

Table 5. Input Signal Definitions

Name	Description
GIN	This signal is the input that controls the Auxiliary Output
IN1	This signal controls Output 1
IN2	This signal controls Output 2
EN	This signal enables Output 1 and Output 2

3.9 Output Signal Definitions

The MPC17510EJ IC has three output signals that are used to drive a DC brushed motor, and an auxiliary output designed to drive a high-side MOSFET. These signals are:

Table 6. Output Signal Definitions

Name	Description
OUT1	Output 1 of the H-Bridge
OUT2	Output 2 of the H-Bridge
Q1D	Auxiliary Output

3.10 Screw Terminal Connections

The FRDM-17510EJ-EVB board features screw terminal connections to allow easy access to MPC17510EJ signals and supply rails.

Table 7. Screw Terminals

Name	Signal	Signal Description
J5	OUT1	H-Bridge output 1
	OUT2	H-Bridge output 2
J6	CRES	Charge pump voltage for H-Bridge and Auxiliary out gate drive
	VM	Motor supply input (this is also the supply for the on board voltage regulator)
	GND	This is the primary ground connection for the motor power supply
J7	Q1D	Auxiliary on board MOSFET output (Drain)
	GND	This is the ground connection intended for the Auxiliary output
	GOUT	Auxiliary output gate drive for off board MOSFET
J8	SNS	Not Used
	ANL	Not Used
	GND	Additional ground

3.11 Jumper J9

The FRDM-17510EJ-EVB has provision (not populated) for a jumper to accommodate higher currents than the on board fuse is capable of handling (1.25 A). If the fuse is bypassed, use extreme care to make sure that the maximum current for the MPC17510EJ is not exceeded (1.2 A nominal, 3.8 A peak/transients).

4 FRDM-KL25Z Freedom Development Platform

The Freescale Freedom development platform is a set of software and hardware tools for evaluation and development. It is ideal for rapid prototyping of microcontroller-based applications. The Freescale Freedom KL25Z hardware, FRDM-KL25Z, is a simple, yet sophisticated design featuring a Kinetis L Series microcontroller, the industry's first microcontroller built on the ARM® Cortex™-M0+ core.

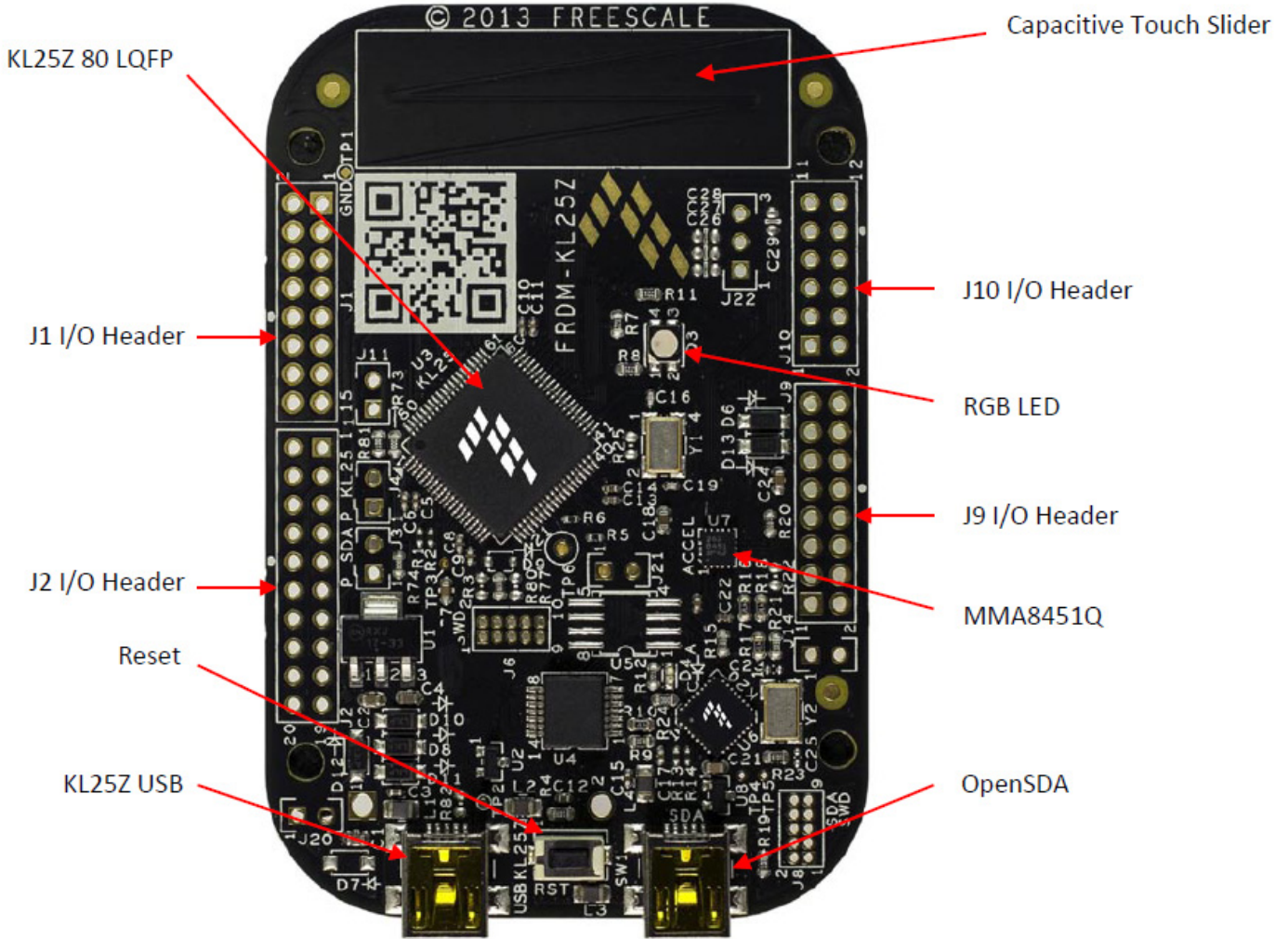

Figure 3. FRDM-KL25Z

4.1 Connecting FRDM-KL25Z to the Board

The FRDM-17510EJ-EVB kit may be used with many of the Freedom platform evaluation boards featuring Kinetis processors. The FRDM-KL25Z evaluation board has been chosen specifically to work with the FRDM-17510EJ-EVB kit because of its low cost and features. The FRDM-KL25Z board makes use of the USB, built in LEDs, and I/O ports available with Freescale's Kinetis KL2x family of microcontrollers. The main functions provided by the FRDM-KL25Z are to allow control of a DC brushed motor using a PC computer over USB, and to drive the necessary inputs on the FRDM-17510EJ-EVB evaluation kit to operate the motor.

The FRDM-17510EJ-EVB is connected to the FRDM-KL25Z using four dual row headers. The connections are as follows:

Table 8. FRDM-17510EJ-EVB to FRDM-KL25Z Connections

FRDM-17510EJ-EVB		FRDM-KL25Z		Pin Hardware Name		Description
Header	Pin	Header	Pin	FRDM-17510EJ-EVB	FRDM-KL25Z	
J1	1	J9	1	GND	PTB8	System Ground
J1	2	J9	2	N/C	SDA_PTD5	No Connection
J1	3	J9	3	GND	PTB9	System Ground
J1	4	J9	4	N/C	P3V3	No Connection
J1	5	J9	5	GND	PTB10	System Ground
J1	6	J9	6	N/C	RESET/PTA20	No Connection
J1	7	J9	7	RUNPWRGD	PTB11	Regulator Voltage Present
J1	8	J9	8	N/C	P3V3	No Connection
J1	9	J9	9	N/C	PTE2	No Connection
J1	10	J9	10	N/C	P5V_USB	No Connection
J1	11	J9	11	N/C	PTE3	No Connection
J1	12	J9	12	GND	GND	System Ground
J1	13	J9	13	N/C	PTE4	No Connection
J1	14	J9	14	N/C	GND	No Connection
J1	15	J9	15	N/C	PTE5	No Connection
J1	16	J9	16	N/C	P5-9V_VIN	No Connection
J2	1	J1	1	EN	PTC7	Enable
J2	2	J1	2	N/C	PTA1	No Connection
J2	3	J1	3	GIN	PTC0	Gen Purpose Auxiliary Input
J2	4	J1	4	N/C	PTD4	No Connection
J2	5	J1	5	N/C	PTC3	No Connection
J2	6	J1	6	IN1	PTD4	Input 1
J2	7	J1	7	N/C	PTC4	No Connection
J2	8	J1	8	IN2	PTA12	Input 2
J2	9	J1	9	READY	PTC5	Green LED (from KL25Z)
J2	10	J1	10	N/C	PTA4	No Connection
J2	11	J1	11	SNSIN	PTC6	Not Used
J2	12	J1	12	N/C	PTA5	No Connection
J2	13	J1	13	N/C	PTC10	No Connection
J2	14	J1	14	N/C	PTC8	No Connection
J2	15	J1	15	N/C	PTC11	No Connection
J2	16	J1	16	N/C	PTC9	No Connection
J3	1	J2	1	N/C	PTC12	No Connection
J3	2	J2	2	N/C	PTA13	No Connection
J3	3	J2	3	N/C	PTC13	No Connection
J3	4	J2	4	N/C	PTD5	No Connection
J3	5	J2	5	N/C	PTC16	No Connection
J3	6	J2	6	N/C	PTD0	No Connection
J3	7	J2	7	N/C	PTC17	No Connection
J3	8	J2	8	N/C	PTD2	No Connection
J3	9	J2	9	N/C	PTA16	No Connection
J3	10	J2	10	N/C	PTD3	No Connection
J3	11	J2	11	N/C	PTA17	No Connection

Table 8. FRDM-17510EJ-EVB to FRDM-KL25Z Connections (continued)

FRDM-17510EJ-EVB		FRDM-KL25Z		Pin Hardware Name		Description
Header	Pin	Header	Pin	FRDM-17510EJ-EVB	FRDM-KL25Z	
J3	12	J2	12	N/C	PTD1	No Connection
J3	13	J2	13	N/C	PTE31	No Connection
J3	14	J2	14	N/C	GND	No Connection
J3	15	J2	15	N/C	N/C	No Connection
J3	16	J2	16	N/C	VREFH	No Connection
J3	17	J2	17	N/C	PTD6	No Connection
J3	18	J2	18	N/C	PTE0	No Connection
J3	19	J2	19	N/C	PTD7	No Connection
J3	20	J2	20	N/C	PTE1	No Connection
J4	1	J10	1	N/C	PTE20	No Connection
J4	2	J10	2	N/C	PTB0	No Connection
J4	3	J10	2	N/C	PTE21	No Connection
J4	4	J10	4	N/C	PTB1	No Connection
J4	5	J10	5	N/C	PTE22	No Connection
J4	6	J10	6	N/C	PTB2	No Connection
J4	7	J10	7	N/C	PTE23	No Connection
J4	8	J10	8	N/C	PTB3	No Connection
J4	9	J10	9	N/C	PTE29	No Connection
J4	10	J10	10	ANLIN	PTC2	Not Used
J4	11	J10	11	N/C	PTE30	No Connection
J4	12	J10	12	N/C	PTC1	No Connection

5 Installing the Software and Setting up the Hardware

5.1 Installing Motor Control GUI on your Computer

The latest version of the Motor Control GUI is designed to run on any Windows 8, Windows 7, Vista or XP-based operating system. To install the software, go to www.freescale.com/analogtools and select your kit. Click on that link to open the corresponding Tool Summary Page. Look for “Jump Start Your Design”. Download to your computer desktop the Motor Control GUI software.

Run the installed program from the desktop. The Installation Wizard guides you through the rest of the process.

To use the Motor Control GUI, go to the Windows Start menu, then Programs, then Motor Control GUI, and click on the Freescale icon. The Motor Control Graphic User Interface (GUI) appears. The GUI is shown in Figure 4. The hex address numbers at the top are loaded with the vendor ID for Freescale (0x15A2), and the part ID (0x138). The left side panel displays these numbers only if the PC is communicating with the FRDM-KL25Z via the USB interface.

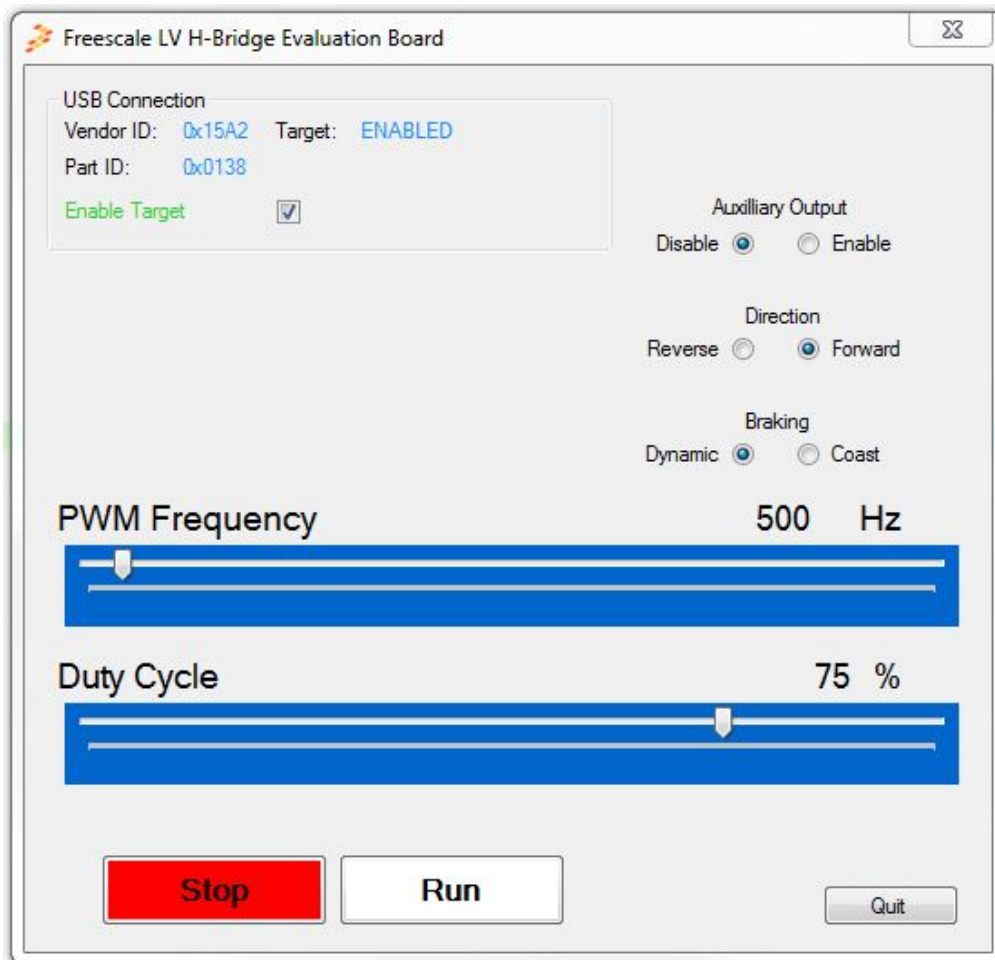

Figure 4. Motor Control GUI

5.2 Configuring the Hardware

Figure 5 shows the configuration diagram for FRDM-17510EJ-EVB.

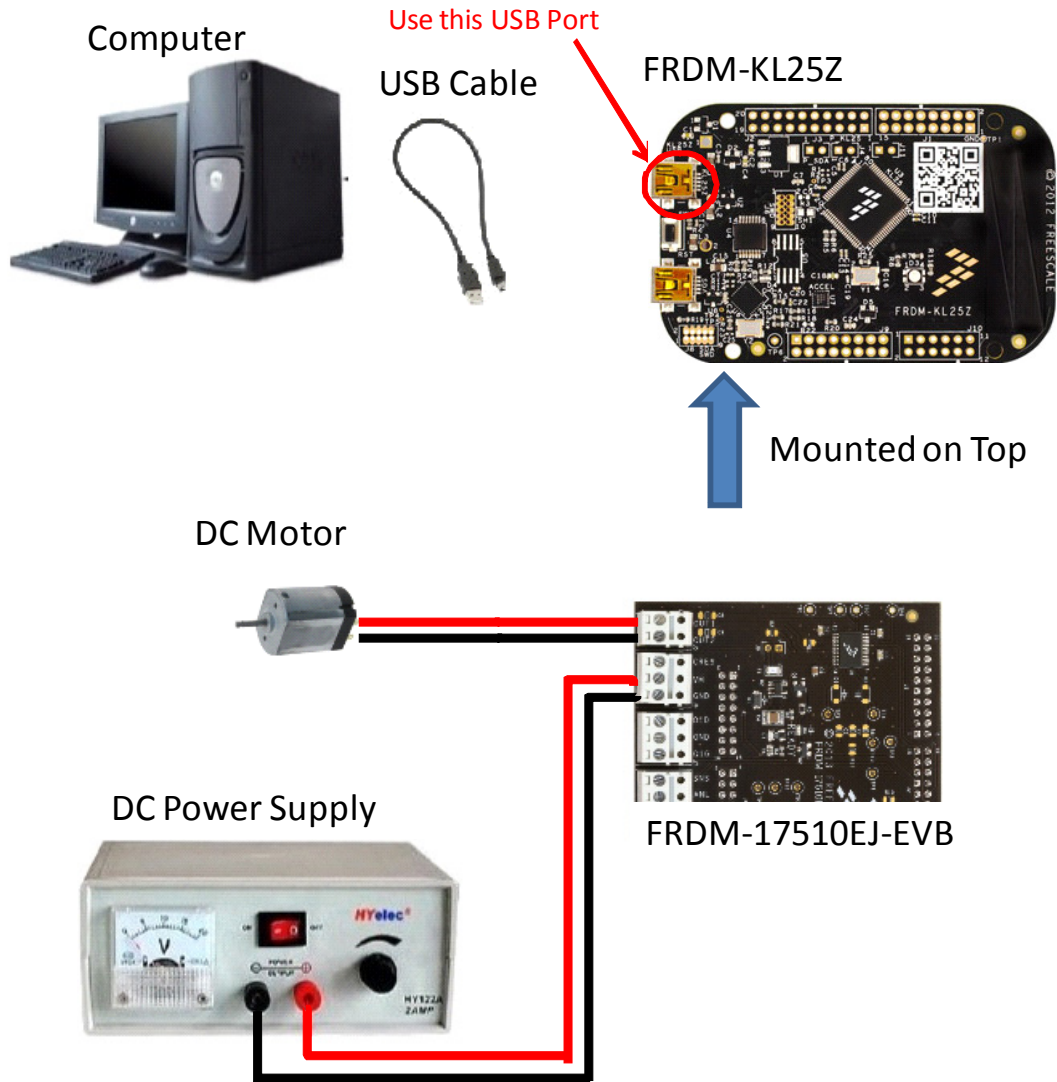

Figure 5. FRDM-17510EJ-EVB Plus FRDM-KL25Z Board Setup

5.2.1 Step-by-step Instructions for Setting up the Hardware

When using the FRDM-17510EJ-EVB make sure that the following operating parameters are followed or damage may occur.

- The maximum motor supply voltage (VM) cannot exceed 15 V, and must be at least 5.0 V
- The nominal operating current of the DC motor cannot exceed 1.2 A (3.8 A peak)
- If the auxiliary output is used, do not exceed 12 V for the motor supply voltage (VM)

In order to perform the demonstration example, first set up the evaluation board hardware and software as follows:

1. Setup the FRDM-KL25Z to accept code from the mbed online compiler. The instructions are at mbed.org

Note: Switch to the other USB port on the FRDM-KL25Z, and back after the project is loaded.

2. Go to the Freescale page on mbed.org (and look for the repository named **LVHB DC Motor Drive**. Save the compiled code on your local drive, and then drag and drop it onto the mbed drive (which is the FRDM-KL25Z). Move the USB connector back to the other USB port on the FRDM-KL25Z.

Note: You may be asked to create a user before you can download the code.

3. Connect the FRDM-17510EJ-EVB to the FRDM-KL25Z (this is best accomplished by soldering female connectors to the FRDM-KL25Z, and then connecting to the male pins provided on the FRDM-17510EJ-EVB)
4. Ready the computer, install the **DC Brushed Motor Driver GUI Software** (See [Installing Motor Control GUI on your Computer on page 12](#) of this User Guide for instructions).
5. Attach DC power supply (without turning on the power) to the VM and GND terminals.
6. Attach a brushed DC motor load to the OUT 1 and OUT 2 output terminals. Optional: Attach an auxiliary output to Q1D (and GND).
7. Launch the **DC Brushed Motor Driver GUI Software**.
8. Make sure the GUI “sees” the FRDM-KL25Z. This can be determined by seeing the hex Vendor ID (0x15A2), and Part ID (0x138) under USB connection in the upper left hand corner of the GUI. If you do not you may need to disconnect and reconnect the USB cable to the FRDM-KL25Z.
9. Turn on the DC power supply.
10. Select **Enable Target** on the GUI. The demo is now ready to run.
11. Click the **Run** button to run the motor. Notice that many options of the GUI are disabled while the motor is running. To make changes, click the **Stop** button on the GUI, make the desired changes, and then click **Run** on the GUI to continue.
12. When finished, click **Enable Target** button on the GUI, and then **Quit**. Turn off DC power supply. Remove USB cable.

6 Installing the Processor Expert Software

6.1 Installing CodeWarrior on your Computer

This procedure explains how to obtain and install the latest version of CodeWarrior (version 10.6 in this guide).

NOTE

The sample software in this kit requires CodeWarrior 10.6 or newer. The component and some examples in the component package are intended for Kinetis Design Studio 3.0.0. If you have CodeWarrior 10.6 and Kinetis Design Studio 3.0.0 already installed on your system, skip this section.

1. Obtain the latest CodeWarrior installer file from the Freescale CodeWarrior website here: http://www.freescale.com/webapp/sps/site/homepage.jsp?code=CW_HOME&tid=vanCODEWARRIOR.
2. Run the executable file and follow the instructions.
3. In the Choose Components window, select the Kinetis component and click on Next to complete the installation.

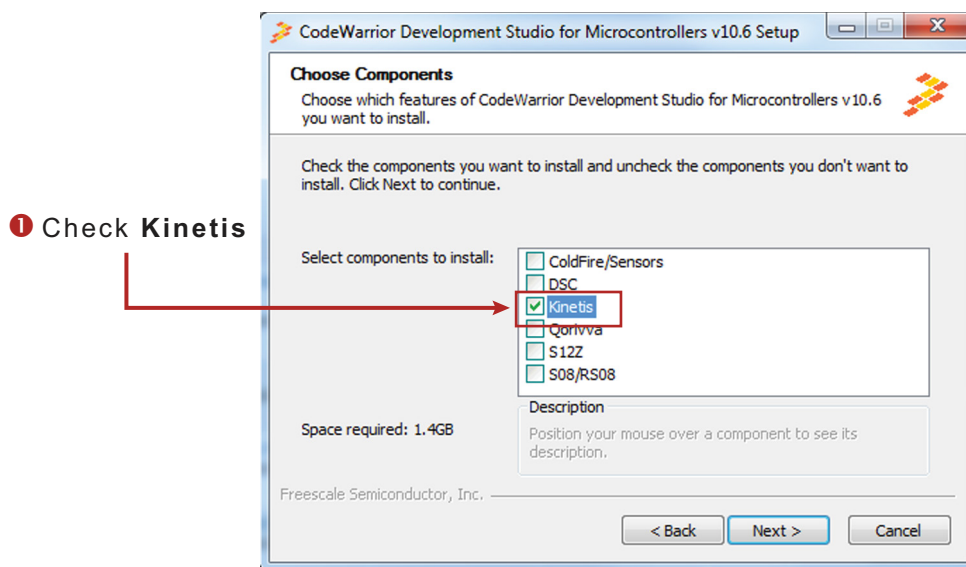

Figure 6. Select Components GUI

6.2 Downloading the LVHBridge Component and Example Projects

The examples used in this section are based on a pre-configured CodeWarrior project. You must first download the project and its associated components:

1. Go to the Freescale website www.freescale.com/LVHBRIDGE-PEXPERT
2. Download example projects and H-Bridge component zip file.
3. Unzip the downloaded file and check that the folder contains the files listed in [Table 9](#).

Table 9. LVHBridge Example Project and Components

Folder Name	Folder Contents
CodeWarrior_Examples	Example project folder for CodeWarrior.
LVH_KL25Z_brush_MC34933	Example project for DC brush motor control using FRDM-34933EP-EVB H-Bridge board and FRDM-KL25Z MCU board
LVH_KL25Z_brush_MPC17510	Example project for DC brush motor control using FRDM-17510EJ-EVB H-Bridge board and FRDM-KL25Z MCU board
LVH_KL25Z_stepper	Example project intended to control stepper motor using FRDM-34933EP-EVB H-Bridge board and FRDM-KL25Z MCU board
LVH_KL25Z_stepper_ramp	Example project intended to control stepper motor using FRDM-34933EP-EVB H-Bridge board and FRDM-KL25Z MCU board. Acceleration ramp is enabled
Component	Processor Expert component folder
KDS_Examples	Example project folder for Kinetis Design Studio 3.0.0 or newer.
LVH_K20D50M_brush_MC34933	Example project for DC brush motor control using FRDM-34933EP-EVB H-Bridge board and FRDM-K20D50M MCU board
LVH_K20D50M_brush_MPC17510	Example project for DC brush motor control using FRDM-17510EJ-EVB H-Bridge board and FRDM-K20D50M MCU board
LVH_K20D50M_stepper_bitIO	Example project intended to control stepper motor using FRDM-34933EP-EVB H-Bridge board and FRDM-K20D50M MCU board
LVH_K20D50M_stepper_ramp_bitIO	Example project intended to control stepper motor using FRDM-34933EP-EVB H-Bridge board and FRDM-K20D50M MCU board. Acceleration ramp is enabled
LVH_KL25Z_brush_MC34933	Example project for DC brush motor control using FRDM-34933EP-EVB H-Bridge board and FRDM-KL25Z MCU board
LVH_KL25Z_brush_MPC17510	Example project for DC brush motor control using FRDM-17510EJ-EVB H-Bridge board and FRDM-KL25Z MCU board
LVH_KL25Z_brush_FreeMASTER	Example project intended to control DC brush motor using FreeMASTER tool. Latest Freemaster installation package: http://www.freescale.com/freemaster
LVH_KL25Z_step_FreeMASTER	Example project intended to control stepper motor using FreeMASTER tool
LVH_KL25Z_stepper	Example project intended to control stepper motor using FRDM-34933EP-EVB H-Bridge board and FRDM-KL25Z MCU board
LVH_KL25Z_stepper_ramp	Example project intended to control stepper motor using MC34933 H-Bridge freedom board and FRDM-KL25Z MCU board. Acceleration ramp is enabled
LVH_KL26Z_stepper	Example project intended to control stepper motor using FRDM-34933EP-EVB H-Bridge board and FRDM-KL26Z MCU board
LVH_KL26Z_stepper_iar	Example project intended to control stepper motor using FRDM-34933EP-EVB H-Bridge board and FRDM-KL26Z MCU board. IAR compiler is used instead of GNU C compiler

6.2.1 Import the LVHBridge Component into Processor Expert Library

1. Launch CodeWarrior by clicking on the CodeWarrior icon (located on your desktop or in Program Files -> Freescale Codewarrior folder.) When the CodeWarrior IDE opens, go to the menu bar and click **Processor Expert -> Import Component(s)**.
2. In the pop-up window, locate the component file (.PEupd) in the example project folder LVHBridge_PEx_SW\Component. Select **LVHBridge_b1508.PEupd** and **ChannelAllocator_b1508.PEupd** files then click **Open** (see [Figure 7](#)).

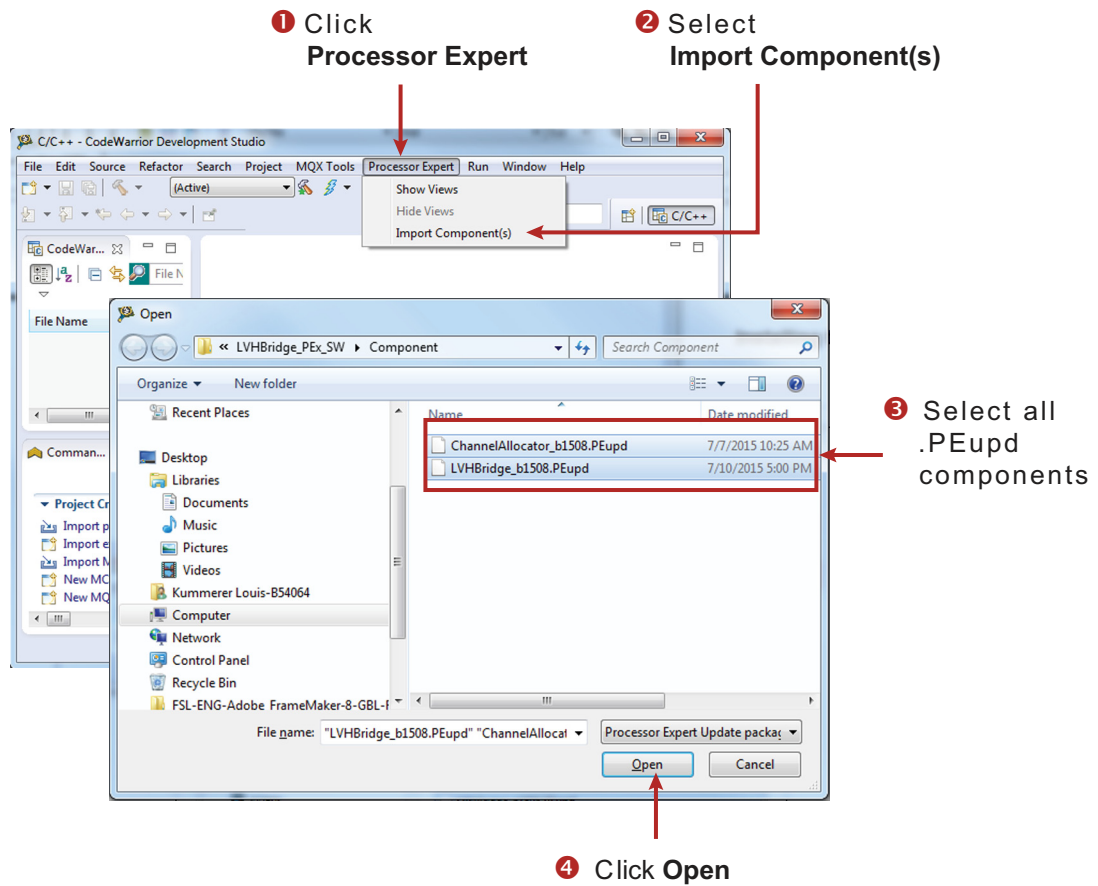

Figure 7. Import LVHBridge Component

3. If the import is successful, the LVHBridge component appears in Components Library -> SW -> User Component (see Figure 8). Note that the component **ChannelAllocator** is not visible, because it is not designed to be users accessible.

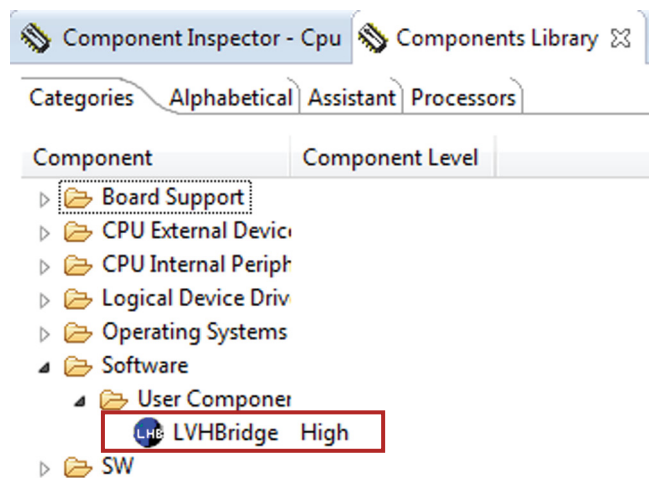

Figure 8. LVHBridge Component Location After CodeWarrior Import

The LVHBridge component is ready to use.

6.2.2 Import an Example Project into CodeWarrior

The following steps show how to import an example from the downloaded zip file into CodeWarrior.

1. In the CodeWarrior menu bar, click **File** -> **Import...** In the pop-up window, select **General** -> **Existing Projects into Workspace** and click **Next**.
2. Locate the example in folder: LVHBridge_PEx_SW\CodeWarrior_Examples (see [Figure 9](#), which shows LVH_KL25Z_brush_MC34933 as the imported project). Then click **Finish**.

The project is now in the CodeWarrior workspace where you can build and run it.

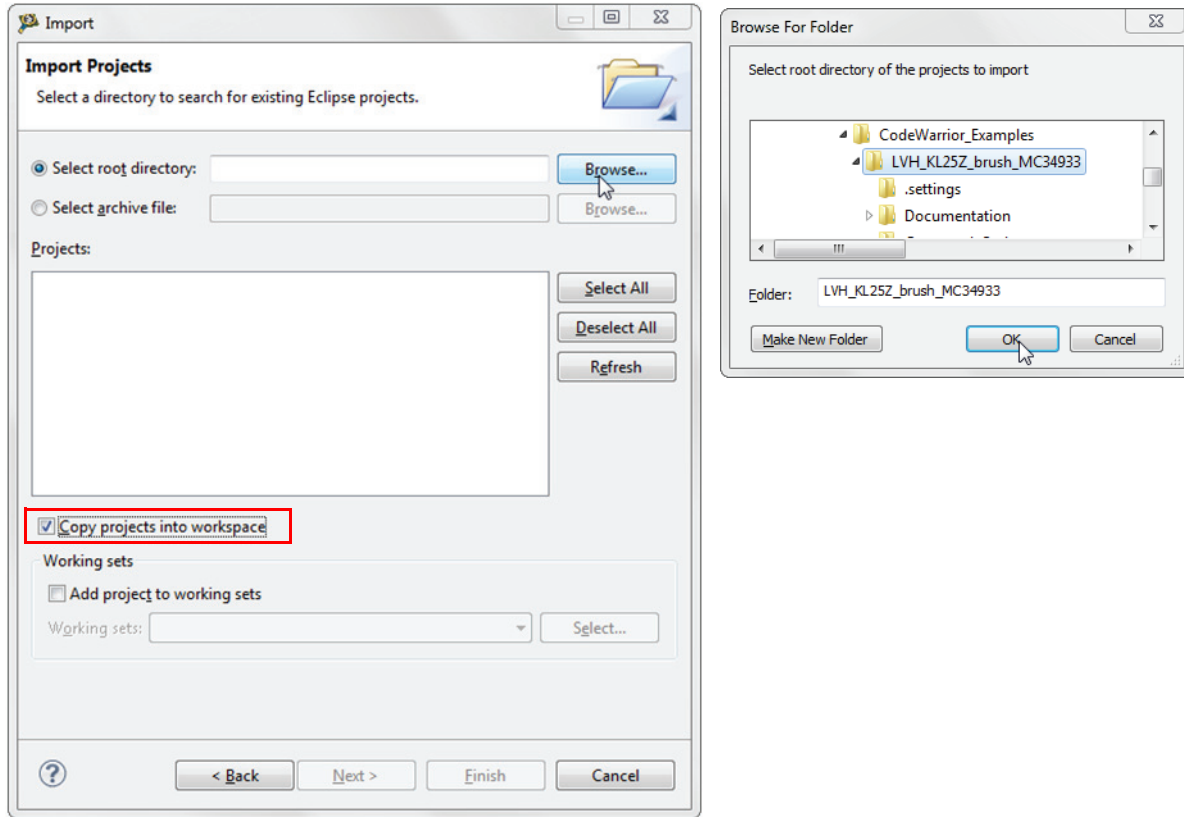

Figure 9. Example Project Import

6.3 Create a New Project with Processor Expert and LVHBridge Component

If you choose not to use the example project, the following instructions describe how to create and setup a new project that uses the LVHBridge component. If you do not have the LVHBridge component in the Processor Expert Library, please follow steps in [Section 6.2.1](#).

1. Create and name an MCU Bareboard project (see [Figure 10](#)).

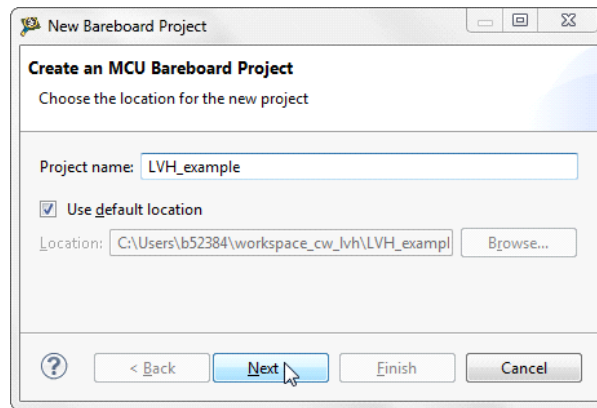

Figure 10. Create an MCU Bare-board Project

2. Choose the MCU class to be used in the freedom MCU board (MKL25Z128 in this example). Then select the connections to be used (see [Figure 11](#)).

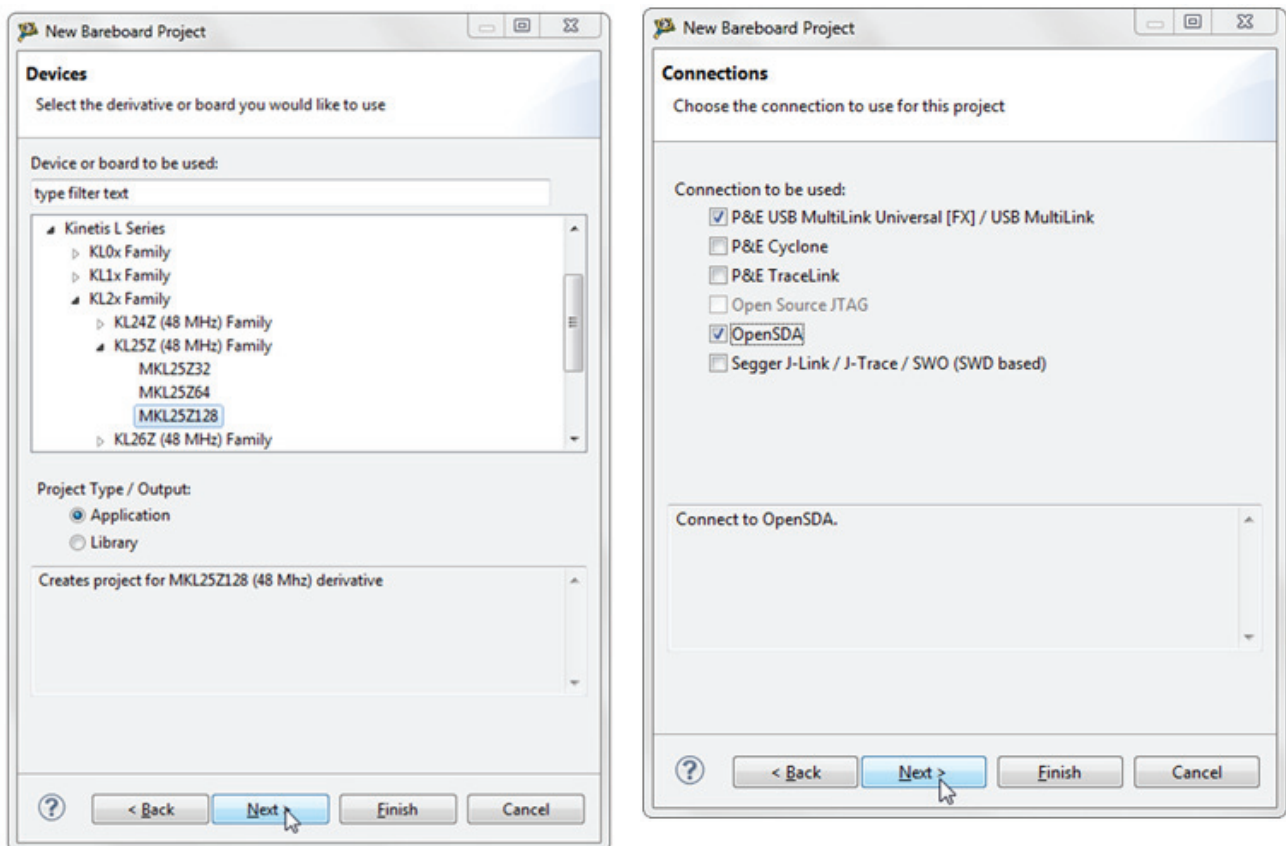

Figure 11. Select the MCU Class and Connections

3. Select the **Processor Expert** option, and then click **Finish** (see [Figure 12](#)).

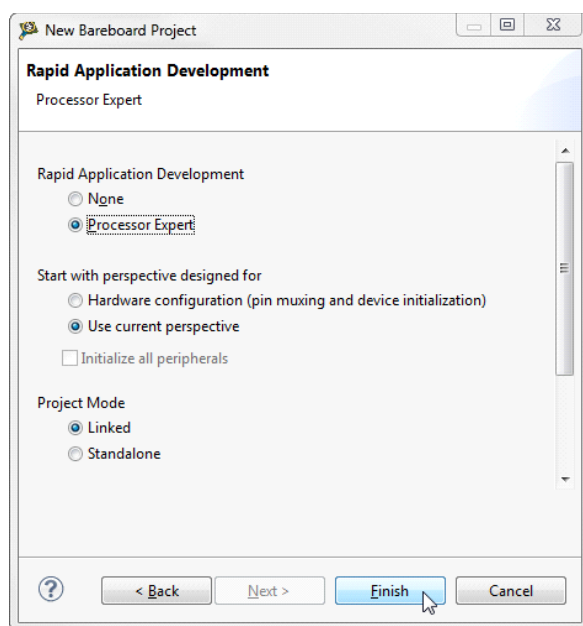

Figure 12. Select the Processor Expert Option

6.3.1 Add LVHBridge Component into the Project

1. Find LVHBridge in the **Components Library** and add it into your project (see [Figure 13](#)).

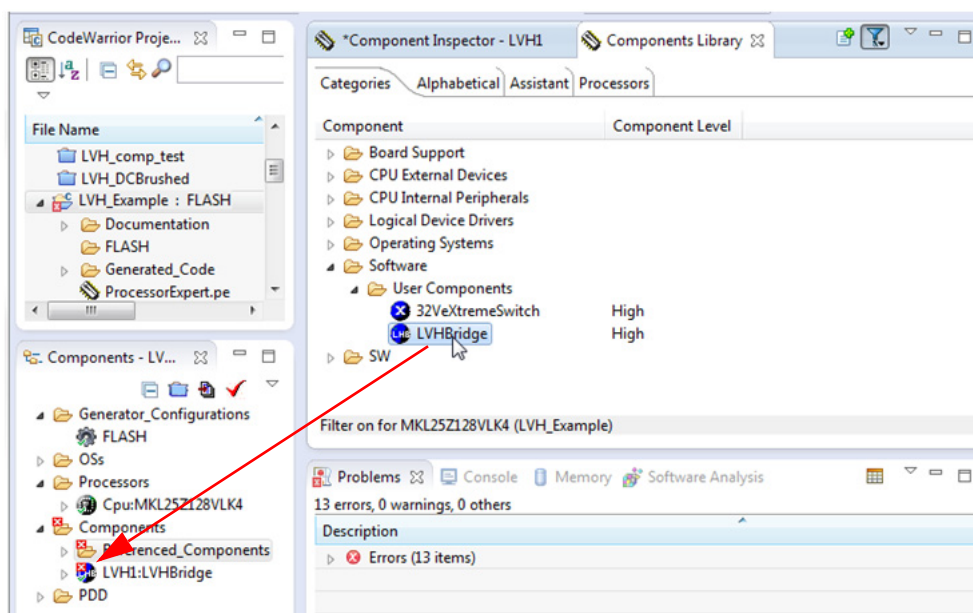

Figure 13. Add the LVHBridge Component to the Project

2. Double click LVHBridge component in the **Components** window (see [Figure 14](#)) to show the configuration in the **Component Inspector** view.

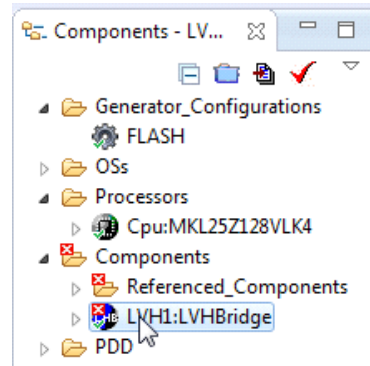

Figure 14. Select the Component

The screenshot shows the 'Component Inspector - LVH1' window with the 'Properties' tab selected. The table below represents the data shown in the inspector.

Name	Value	Details
Component Name	LVH1	
▼ H-Bridge Model	MPC17510	
ActiveMode	yes	
▲ Enable Pins	Enabled	
Pin for EN	PTE0/UART1_TX/RTC_CLKOUT/C...	
Pin for GIN	PTE2/SPI1_SCK	
▼ Motor Control	Brushed	
▼ Timer Settings	Enabled	
Primary Timer Component	TU1	
▼ Primary Timer Device	LPTMR0_CNR	Unsupported counter device LPTMR0_CNR, please
▶ Secondary Timer	Disabled	
▼ H-Bridge 1 MCU Interface		
▼ DC brush		
▼ Control Mode	Speed Control	
▼ PWM Frequency		Unassigned timing
Direction Control	Bidirectional	
Init. Direction	Forward	
▼ Input Control Pins	Two PWM Pins	
▼ Pin for IN1	PTE4/SPI1_PCS0	Selected peripheral "PTE4/SPI1_PCS0" does not m
▼ Pin for IN2	PTE5	Selected peripheral "PTE5" does not match HW re
Auto Initialization	yes	

Figure 15. Component Inspector View

6.3.2 General Settings of LVHBridge Component

Component settings in the **Component Inspector** view have a tree structure. H-Bridge Model is on top of the tree.

ActiveMode defines the H-Bridge device operational mode (normal or power-conserving sleep mode), which is controlled by the enabling pin. Selection of the enabling pin is in the **Enable Pins** group. For more information, see your H-Bridge model's data sheet. The mode can be changed later using the C code method **SetMode**.

The **Motor Control** group involves timer settings, H-Bridge device and motor control settings. The **Timer Settings** group contains the **Primary Timer Component** property (the name of a linked **TimerUnit_LDD** component) and the name of the hardware timer being used (defined in the **Primary Timer Device** property). **Secondary Timer** encompasses the properties of an additional timer.

Note that the **Secondary Timer Component** property must use a different **TimerUnit_LDD** component than the **Primary Timer Component** property. The purpose of the primary and secondary timers is to allow the input control pins of an H-Bridge device to be connected to different timers (this applies for some freedom H-Bridge boards and freedom MCUs). But these timers must be synchronized to control a stepper motor. So the primary timer is designed to be the source for the global time base and the secondary timer is synchronized with the primary timer. Please see your MCU's data sheet to find out which timer provides the global time base (GTB) and set the **Primary Timer Device** property accordingly. An example of a timer selection using the FRDM-KL25Z MCU is shown in [Figure 16](#). If you are using a single timer, set the **Secondary Timer Component** to **Disabled**.

▲ Timer Settings	Enabled	
Primary Timer Component	TU1	
Primary Timer Device	TPM1_CNT	TPM1_CNT
▲ Secondary Timer	Enabled	
Secondary Timer Component	TU2	
Secondary Timer Device	TPM0_CNT	TPM0_CNT

Figure 16. Selection of a FRDM-KL25Z MCU Primary and a Secondary Timer Device

H-Bridge 1 MCU Interface and H-Bridge 2 MCU Interface allow you to set H-Bridge control function. The H-Bridge 2 MCU Interface is shown only for dual H-Bridge models (for example MC34933). The DC Brush group is described in [Setting up a Project to Control a DC Brushed Motor on page 23](#). The **Input Control Pins** allow you to select the H-Bridge input control pins that utilize timer or GPIO pin channels.

▲ H-Bridge 1 MCU Interface		
▲ DC brush		
▲ Control Mode	Speed Control	
PWM Frequency	10 kHz	10.001 kHz
Direction Control	Bidirectional	
Init. Direction	Forward	
▲ Input Control Pins	Two PWM Pins	
Pin for IN1A	PTD4/LLWU_P14/SPI1_PCS0/UART...	
Pin for IN1B	PTA12/TPM1_CH0	
▲ H-Bridge 2 MCU Interface	Enabled	
▲ DC brush		
Control Mode	State Control	
Init. Direction	Forward	
▲ Input Control Pins	Two GPIO Pins	
Pin for IN2A	TS10_CH5/PTA4/I2C1_SDA/TPM0_...	
Pin for IN2B	PTA5/USB_CLKIN/TPM0_CH2	
Auto Initialization	yes	

Figure 17. LVHBridge Component — General Settings

6.3.3 Setting up a Project to Control a DC Brushed Motor

1. Select the H-Bridge model you want to configure and set the **Motor Control** property to **Brushed**.

Name	Value	Details
Component Name	LVH1	
▲ H-Bridge Model	MPC17510	
ActiveMode	yes	
▲ Enable Pins	Enabled	
Pin for EN	CMP0_IN1/PTC7/SPI0_MISO/SPI0_...	
Pin for GIN	ADC0_SE14/TS10_CH13/PTC0/EXT...	
▲ Motor Control	Brushed	
▲ Timer Settings	Enabled	
Primary Timer Component	TU1	
Primary Timer Device	TPM0_CNT	TPM0_CNT
▲ Secondary Timer	Enabled	
Secondary Timer Component	TU2	
Secondary Timer Device	TPM1_CNT	TPM1_CNT
▲ H-Bridge 1 MCU Interface		
▲ DC brush		
▲ Control Mode	Speed Control	
PWM Frequency	10 kHz	10.001 kHz
Direction Control	Bidirectional	
Init. Direction	Forward	
▲ Input Control Pins	Two PWM Pins	
Pin for IN1	PTD4/LLWU_P14/SPI1_PCS0/UART...	
Pin for IN2	PTA12/TPM1_CH0	
Auto Initialization	yes	

Figure 18. Setup of the Component to Control a Brush Motor

2. Set the **Control Mode** property. There are two ways to control the DC brushed motor:
 - a) **Speed Control** - motor speed is controlled by your settings. The **TimerUnit_LDD** component is used to generate the PWM signal. The **PWM Frequency** property is visible in this mode only. If you set the **Speed Control** mode on both interfaces (i.e. Interface 1 and Interface 2), the **PWM Frequency** property on Interface 2 is set automatically to the same value as Interface 1 (because Interface 2 uses the same timer.)
 - b) **State Control** - motor is controlled by GPIO pins (**BitIO_LDD** components). This means you can switch the motor on or off without speed adjustments. The advantage of this mode is that you do not need timer channels. If you set **State Control** on both interfaces or you have only a single H-Bridge model (one interface) with **State Control**, the **TimerUnit_LDD** component is not required anymore by the LVHBridge component and you can remove it from the project.
3. Set the PWM Frequency.
4. Set the **Direction Control** property. The **Direction Control** property determines what direction the motor is allowed to move in. Setting the property to **Forward** restricts the motor's movement to the forward direction only. Setting the property to **Reverse** restricts movement to the reverse direction only. A **Bidirectional** setting allows the motor to move in either direction. The **Bidirectional** mode requires two timer channels. **Forward** or **Reverse** requires only one timer channel and one GPIO port. This setting is available only when **Speed Control** mode is set in the **Control Mode** property.

6.3.4 Generating Application Code

After configuration, generate the source code by clicking on the icon in the upper right corner of the Components screen.

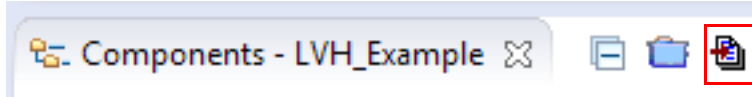

Figure 19. Generating the Source Code

The driver code for the H-Bridge device is generated into the **Generated_Code** folder in the project view. The component only generates application driver code. It does not generate application code.

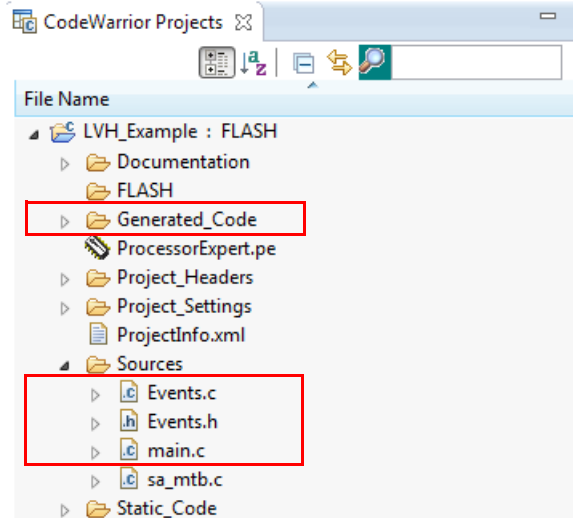

Figure 20. Generated Files

6.3.5 Using the Interface

Application code can be written and tested in the project. For example, you can open the LVHBridge component method list, drag and drop **RotateProportional** to **main.c** (see Figure 21), add any necessary parameters, then compile the program.

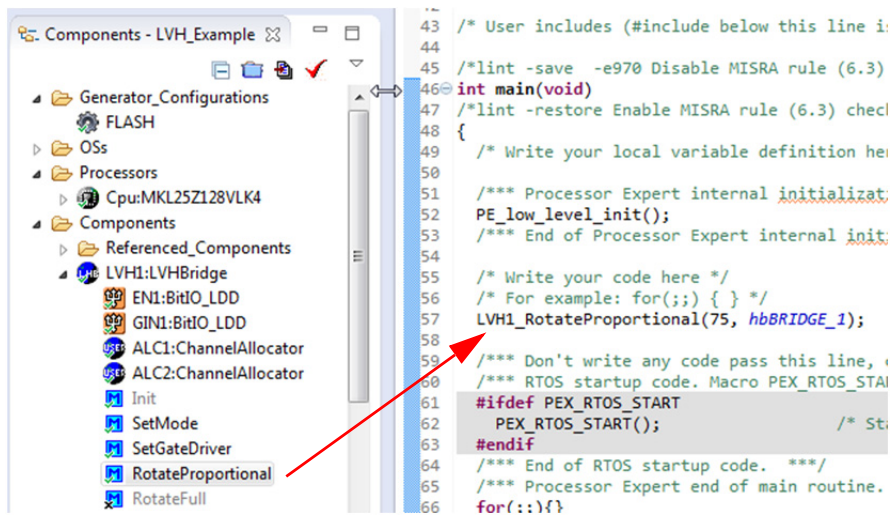

Figure 21. Using the Interface

To compile, download and debug on board, click compile, then click the debug icon in the toolbar. CodeWarrior downloads and launch the program on board (see [Figure 22](#)).

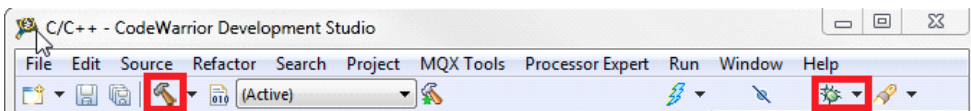

Figure 22. Compile and Download the Application

A description of each LVHBridge method appears in the pop-up window (see [Figure 23](#)).

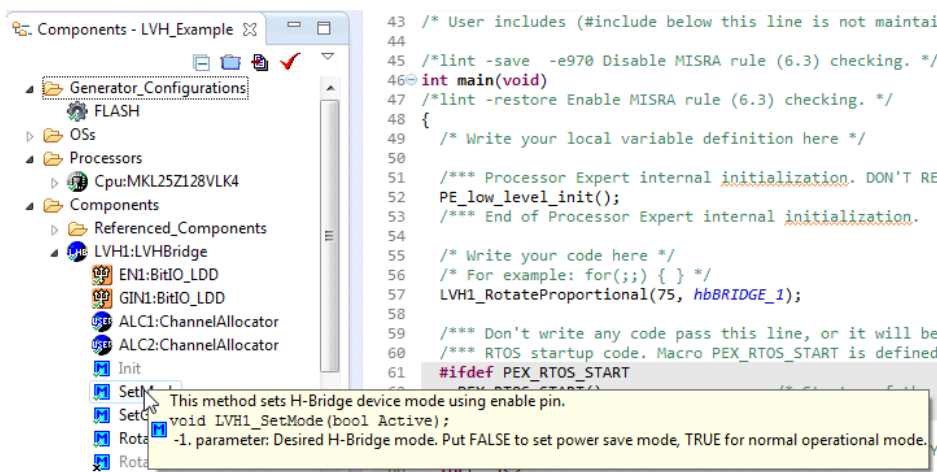

Figure 23. LVHBridge Method Information

6.4 Frequently Asked Questions

Q: How do I set up the LVHBridge component when two or more components with conflicting values are configured to control brushed motors? (See [Figure 24](#))

▼ H-Bridge 1 MCU Interface		
▼ DC brush		
▼ Control Mode	Speed Control	
▼ PWM Frequency	5 kHz	Conflict in required values from components in the project
Direction Control	Bidirectional	

Figure 24. Conflict in the Required Values for Components in the Project

A: You can use more LVHBridge components in same project. These components can share the same timer device in brushed motor control mode, but **PWM Frequency** and **Timer Device** properties must conform in all of the components.

Q: I sometimes get the following unexpected error while generating Processor Expert code: "Generator: FAILURE: Unexpected status of script: Drivers\Kinetis\TimerUnit_LDD.drv, please contact Freescale support". What causes this?

A: Occasionally, when you enable the LVHBridge component in your project, the **TimerUnit_LDD** component channels have not been allocated. If this occurs, changing certain LVHBridge properties forces allocation of the channels. If you are configuring a stepper motor (**Motor Control** property set to **Stepper**), try changing the **Output Control** property to **GPIO** and then back to **PWM**. If you are configuring a brushed motor (**Motor Control** property set to **Brushed**), change the **Control Mode** property to **State Control** and then back to **Speed Control** on interface 1 or interface 2.

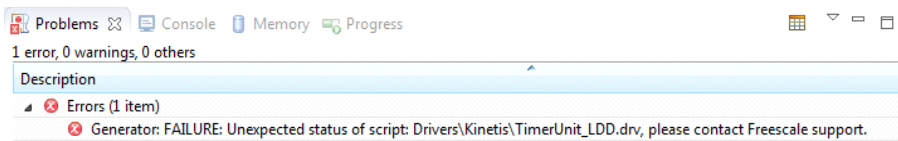
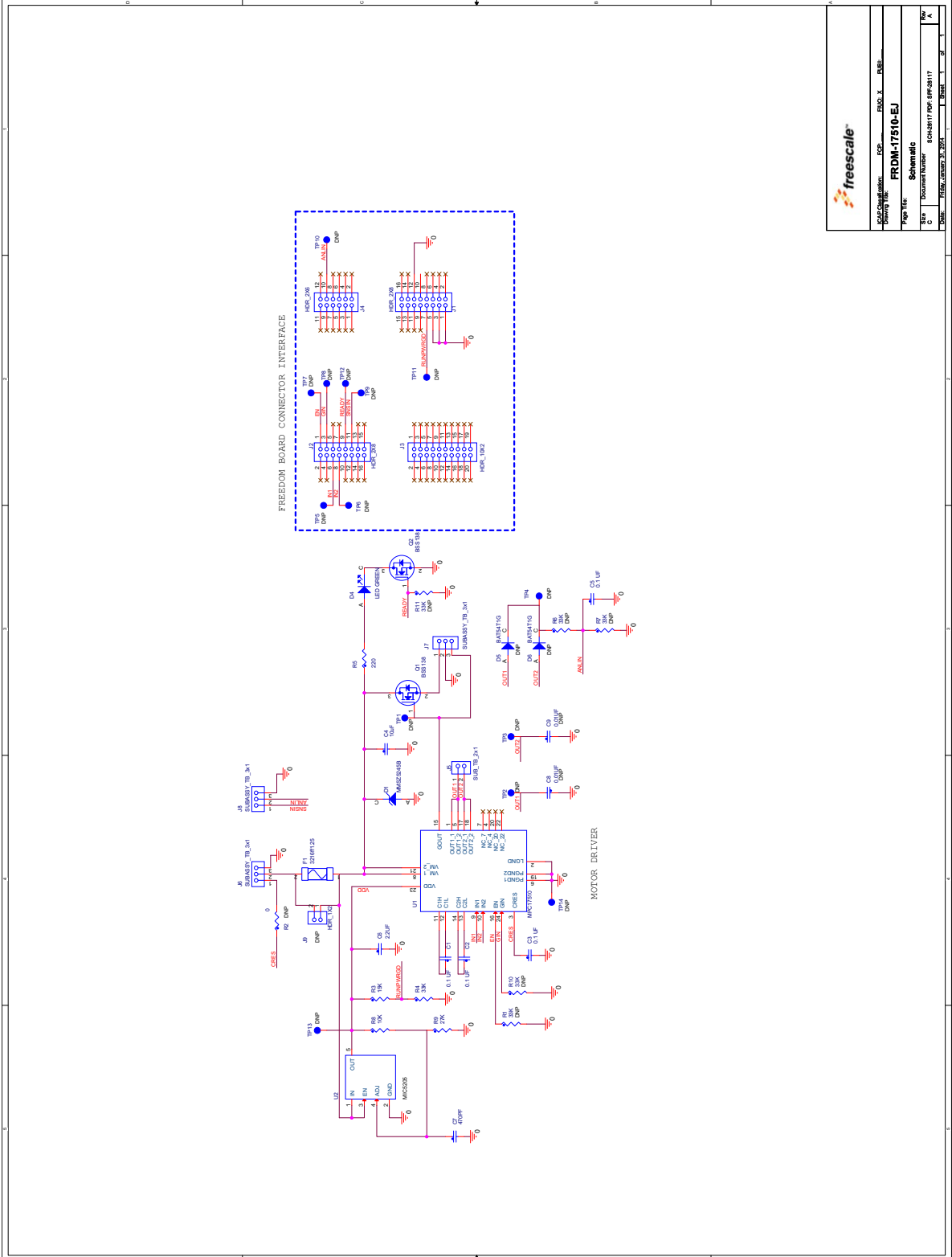

Figure 25. Unexpected Error Related to the LVHBridge TimerUnit_LDD Component

- Q: I have set up several CPU clock configurations (via the **Clock configurations** property of the CPU component.) Sometimes during runtime, when I switch between these configurations (using the CPU **SetClockConfiguration** method), the speed of the stepper motor appears to be inaccurate. Why does this occur?
- A: Switching to a different configuration results in the use of a different input frequency by a timer device. LVHBridge may not pick up the new value and continues to use the previous value in its calculations.
- Q: What does the error message "The component has no method to enable its event (OnCounterRestart)" raised in an LVHBridge TimerUnit_LDD component mean?
- A: This occurs only when you add an LVHBridge component to a project and set the **Motor Control** property to **Stepper**. The error disappears if you change any property of the LVHBridge component.

7 Schematic



Doc ID: 5200	Doc. X: DUB-
Doc. Name: FPC	Doc. X: FRDM-17510-EJ
Doc. Title: Schematic	Doc. X: SCH2117PFC-8P23117
Doc. Rev: 1.0	Doc. X: 1.0

Figure 26. Evaluation Board Schematic

8 Board Layout

8.1 Silkscreen

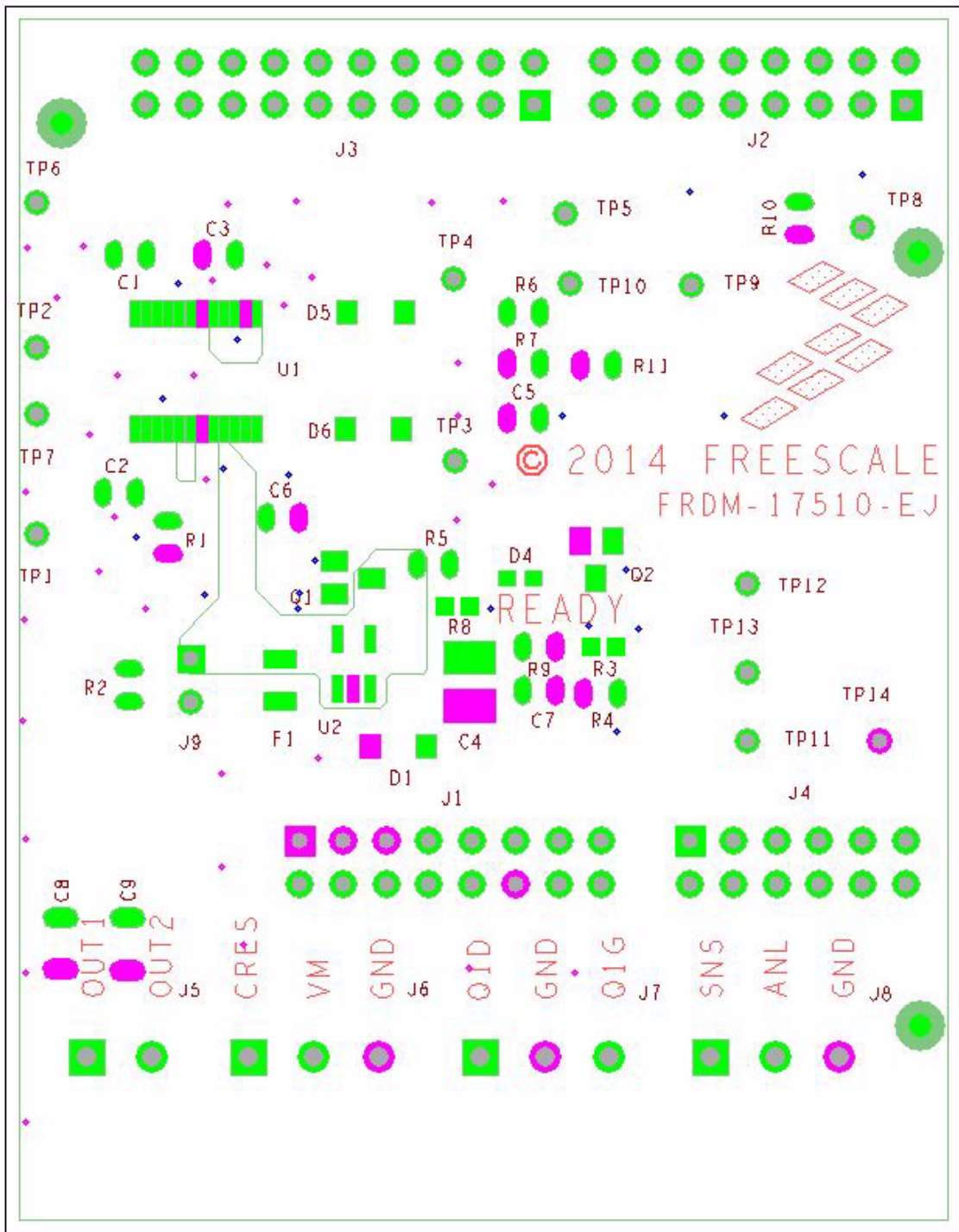

9 Board Bill of Materials

 Table 10. Bill of Materials ⁽¹⁾

Item	Qty	Schematic Label	Value	Description	Part Number	Assy Opt
Active Components						
1	1	U1		Freescale MPC17510EJ H-Bridge Motor Driver	MPC17510EJ	(2)
2	1	U2		MIC5205 Linear Reg LDO 1.5-15 V 150 MA 2.5-16 V	MIC5205	(2)
Transistors						
3	2	Q1, Q2	SOT-23	Transistor NMOS 50 V 220 MA	BSS138	
Diode						
4	1	D1	SOD123	Diode Zener -- 15 V 0.5 W	MMSZ5245B	
LED						
5	1	D4	0603	LG L29K-G2J1-24-Z	LED Green Single 20 MA	
Capacitors						
6	3	C1, C2, C3	0.1 μ F	Ceramic 0.1 μ F 50 V 10% X7R	0805	
7	1	C4	10 μ F	Ceramic 10 μ F 35 V 10% X7R	1210	
8	1	C6	2.2 μ F	Ceramic 2.2 μ F 16 V 10% X7R	0805	
9	1	C7	0.01 μ F	Ceramic 0.01 μ F 50 V 5% X7R	1206	
Fuse						
10	1	F1	1.25 A	Fuse Fast 1.25 A 63 V SMT		
Resistors						
11	1	R3	15 K	Metal Film 15.0 K 1/10W 1%	0603	
12	1	R4	33 K	Metal Film 33 K 1/8W 5%	0805	
13	1	R5	220 Ω	Metal Film 220 OHM 1/8W 1%	0805	
14	1	R8	10 K	Metal Film 10 K 1/10W 5%	0603	
15	1	R9	27 K	Metal Film 27 K 1/8W 5%	0805	
Connectors						
16	2	J1, J2	HDR 2X8	HDR 2X8 TH 100MIL CTR TSW-108-07-G-D SAMTEC		
17	1	J3	HDR 2X10	HDR 2X10 TH 100MIL CTR TSW-110-07-S-D SAMTEC		
18	1	J4	HDR 2X6	HDR 2X6 TH 100MIL CTR TSW-106-07-S-D SAMTEC		
19	1	J5	TERM BLOCK 1x2	SUBASSEMBLY CON 1X3 TB TH 3.81MM SP 201H -- 138L + TERM BLOCK PLUG 3.81 MM 2 POS		
20	3	J6, J7, J8	TERM BLOCK 1x3	SUBASSEMBLY CON 1X3 TB TH 3.81MM SP 201H -- 138L + TERM BLOCK PLUG 3.81 MM 3 POS210-80099, 211-79220		

Notes

1. Freescale does not assume liability, endorse, or warrant components from external manufacturers are referenced in circuit drawings or tables. While Freescale offers component recommendations in this configuration, it is the customer's responsibility to validate their application.
2. **Critical components.** For critical components, it is vital to use the manufacturer listed.

10 References

Following are URLs where you can obtain information on related Freescale products and application solutions:

Freescale.com Support Pages	Description	URL
FRDM-17510EJ-EVB	Tool Summary Page	www.freescale.com/FRDM-17510EJ-EVB
MPC17510	Product Summary Page	www.freescale.com/webapp/sps/site/prod_summary.jsp?code=MPC17510
FRDM-KL25Z	Tool Summary Page	www.freescale.com/webapp/sps/site/prod_summary.jsp?code=FRDM-KL25Z
mbed	Home Page	mbed.org
Processor Expert	Tool Summary Page	www.freescale.com/webapp/sps/site/homepage.jsp?code=BEAN_STORE_MAIN&fsrch=1
CodeWarrior	Tool Summary Page	www.freescale.com/webapp/sps/site/homepage.jsp?code=CW_HOME&tid=vanCODEWARRIOR
Processor Expert Code Model	Code Walkthrough Video	www.freescale.com/video/processor-expert-code-model-codewarrior-code-walkthrough:PROEXPCODMODCW_VID

10.1 Support

Visit www.freescale.com/support for a list of phone numbers within your region.

10.2 Warranty

Visit www.freescale.com/warranty to submit a request for tool warranty.

11 Revision History

Revision	Date	Description of Changes
1.0	10/2014	<ul style="list-style-type: none"> • Initial Release
2.0	9/2015	<ul style="list-style-type: none"> • Added Processor Expert section

How to Reach Us:

Home Page:
freescale.com

Web Support:
freescale.com/support

Information in this document is provided solely to enable system and software implementers to use Freescale products. There are no express or implied copyright licenses granted hereunder to design or fabricate any integrated circuits based on the information in this document.

Freescale reserves the right to make changes without further notice to any products herein. Freescale makes no warranty, representation, or guarantee regarding the suitability of its products for any particular purpose, nor does Freescale assume any liability arising out of the application or use of any product or circuit, and specifically disclaims any and all liability, including without limitation consequential or incidental damages. "Typical" parameters that may be provided in Freescale data sheets and/or specifications can and do vary in different applications, and actual performance may vary over time. All operating parameters, including "typicals," must be validated for each customer application by customer's technical experts. Freescale does not convey any license under its patent rights nor the rights of others. Freescale sells products pursuant to standard terms and conditions of sale, which can be found at the following address: freescale.com/SalesTermsandConditions.

Freescale, the Freescale logo, Processor Expert, CodeWarrior, and Kinetis are trademarks of Freescale Semiconductor, Inc., Reg. U.S. Pat. & Tm. Off. SMARTMOS is a trademark of Freescale Semiconductor, Inc. All other product or service names are the property of their respective owners.

© 2015 Freescale Semiconductor, Inc.

Document Number: KTFRDM17510EJUG
Rev. 2.0
9/2015